

## CY-FOSC-5603 series Fiber Optic Splice Closure specification

### Description

CY-FOSC-5603 type of FOSC is designed for connection and protection of fiber cables. This model has 1 uncut port, 4 drop cable ports. It can be used for different applications of optical fiber cable splicing & branching and is suitable for aerial, pipe-lined, manhole and direct buried applications. It applies to any sort of cables (loose tube, skeleton, ribbon etc.)

### Features

- Made of modified engineering plastic with high strength, anti-impact and anti-corrosion.
- Cable diameter: 1 uncut port support  $\varnothing 8 \sim 18\text{mm}$  cable; 4 branch ports support  $\varnothing 8 \sim 18\text{mm}$  cable
- Capacity: max capacity is up to 48f, the splice tray can support 1:16 mini splitter. The closure also can accommodate 16 pcs SC adapters.
- Installation method: Suitable for direct buried, aerial, pole, pipeline, manhole, etc.
- Sealing: mechanical seal is adopted for box body and cable mouth, with protection grade of IP68.



## Specifications





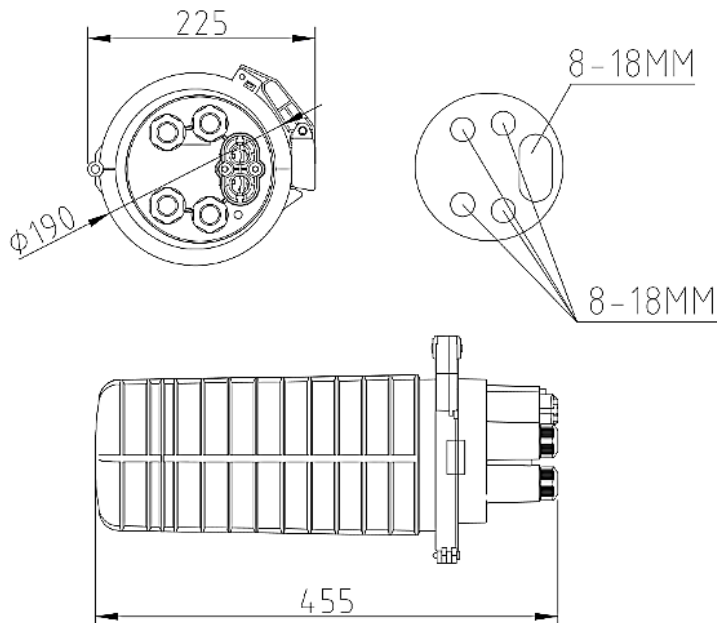







Style	Dome		
Dimensions(mm)	455 × Φ225		
Weight (kg)	3.5 – 4.0		
Material	PP+GF		
Sealing Type	Mechanical Seal		
Protection Grade	IP68		
Cable ports	Oval port	1	Φ8 - Φ18 mm
	Branch port	4	Φ8 - Φ18 mm
Closure Max Capacity	Single fiber splicing		48F
Splice Tray Capacity	Single fiber splicing per tray		24F
Max No. tray installed	2pc		
Adapter	SC		18pc
PLC Splitter	2pc 1:4 or 2pc 1:8 or 1pc 1:16 splitter		
Installation	Aerial, wall, pole, manhole etc.		

## Structure drawing







## Accessory list

Standard accessories (Picture only for reference)

Item	Description	Qty	Picture
1	Wrench	1 pc	
2	Allen Spanner	1 pc	
3	Grommet for uncut port	2 pcs	
4	Grommet for branch port	8 pcs	
5	Insulation tap	1 roll	
6	Splicing protective tube	1 bag	
7	Nylon cable tie	1 bag	
8	Choke plug	6 pcs	
9	Installation manual	1 set	
10	EVA tube	1 roll	
11	Clean paper	1 pc	
12	Silicon oil	1 pc	

Optional accessory

Item	Description	Qty	Picture
1	Air Valve	1set	
2	Ground lead	1 set	
3	Aerial mounting fittings	1 set	
4	Pole mounting fittings	1 set	
5	Wall mounting fittings	1set	

## Packaging information

Product Dimension	Gift Box Dimension	Outer carton Dimension
455 × Φ225 mm	475×235×205 mm (1 PC)	740×500×450 mm (6 PCS)

### Ordering information

Part Number	Description
CY-FOSC-5603	Dome type Fiber Optic Splice Closure, IP68 grade, 1 uncut port, 4 branch ports. 2 * 24f fiber splice tray. Optional of 2pcs 1:4 or 2pcs 1:8 or 1pcs 1:16 splitter.