

CY-FOSC-5601 series Fiber Optic Splice Closure specification

Description

CY-FOSC-5601 fiber optic splice closure is designed for connection and protection of fiber cables. This model has one uncut port, four branch ports, two drop cable ports. It can be used for different applications of optical fiber cable splicing & branching and is suitable for aerial, pipe-lined, manhole and direct buried applications. It applies to any sort of cables (loose tube, skeleton, ribbon etc.)

Features

- Cable diameter: 1 uncut port and 4 branch ports can support $\phi 3\sim 5\text{mm}$ cables, can be customized;
- Product capacity: Single fiber max capacity is up to 144f, also support max 432f ribbon fiber
- Installation method: Suitable for direct buried, aerial, pole, pipeline, manhole, etc.
- Sealing mode: mechanical seal is adopted for cable ports, with protection grade of IP68.
- Splice tray can accommodate mini-PLC if required. Also, can accommodate micro cable with grommet



Specifications

Technical Specification			
Style	Dome		
Dimensions(mm)	455 × Φ225		
Weight (kg)	3.5 - 4.5		
Material	PP+GF		
Sealing Type	Mechanical Seal		
Protection Grade	IP68		
Cable ports	Oval port	1	Φ3 – Φ5 mm
	Branch port	4	Φ3 – Φ5 mm
Closure Max Capacity	Single fiber splicing		144f
	Ribbon fiber splicing		432f / 576f
Splice Tray Capacity	Single fiber splicing per tray		24f
	Ribbon fiber splicing per tray		6f / 12f band
Max No. tray installed	6pc		
PLC Splitter	1pc splitter		
Installation	Aerial, wall, pole, manhole etc.		



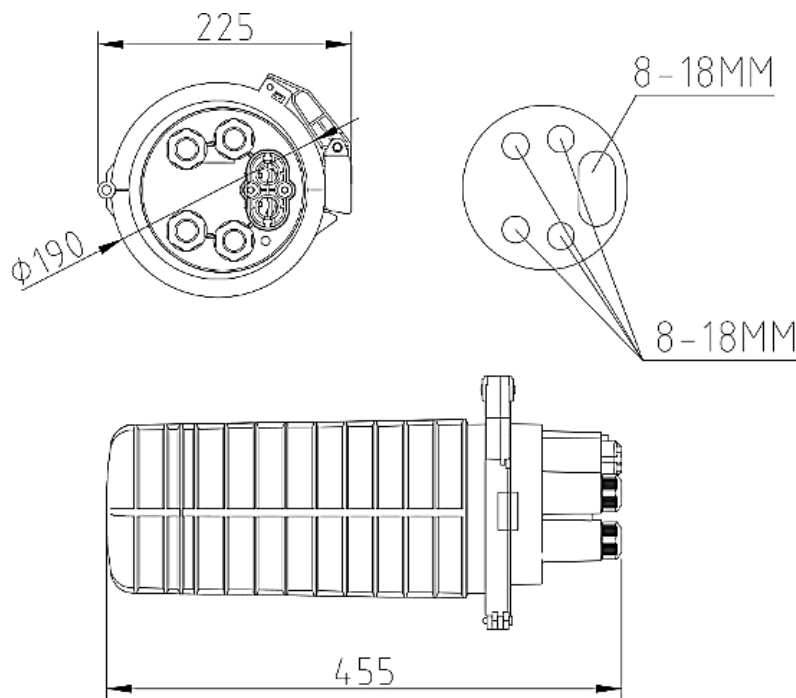



Structure Drawings



Cable hole can be customized, 3-5mm or 8-18mm

Accessory list

Standard accessories (Picture only for reference)

Item	Description	Qty	Picture
1	Wrench	1 pc	
2	Allen Spanner	1 pc	
3	Grommet for uncut port	2 pcs	
4	Grommet for branch port	8 pcs	
5	Insulation tap	1 roll	
6	Splicing protective tube	1 bag	
7	Nylon cable tie	1 bag	
8	Choke plug	6 pcs	
9	Installation manual	1 set	
10	EVA tube	1 roll	
11	Clean paper	1 pc	
12	Silicon oil	1 pc	

Optional accessories (Picture only for reference)

Item	Description	Qty	Picture
1	Air Valve	1set	
2	Ground lead	1 set	
3	Aerial mounting fittings	1 set	
4	Pole mounting fittings	1 set	
5	Wall mounting fittings	1set	

Packaging information

Product Dimension	Gift Box Dimension	Outer carton Dimension
455 × Φ225	475×235×205 mm (1 PCS)	740×490×450 mm (6 PCS)

Ordering information

Part Number	Description
CY-FOSC-5601-A-BBB	Fiber Optic Splice Closure, IP68 grade, with selection of single fiber splicing (max 144 fiber with 6 trays) or ribbon fiber splicing (max 432 or 576 fiber with 6 trays).
	Fiber Splice Type A S – Single fiber splicing R – Ribbon fiber splicing
	Maximum Fiber Splice Capacity BBB 144 – Single fiber splicing, 24 fiber per tray with 6 trays 432 – for Ribbon fiber splicing, 6 fiber band per tray with 6 trays 576 – for Ribbon fiber splicing, 12 fiber band per tray with 6 trays

Example: CY-FOSC-5601-S-144